

Varenummer: 2310431159S
Beskrivelse: E+G Stilleben
LX.30-SW17-SST-M8X23-S

Mål

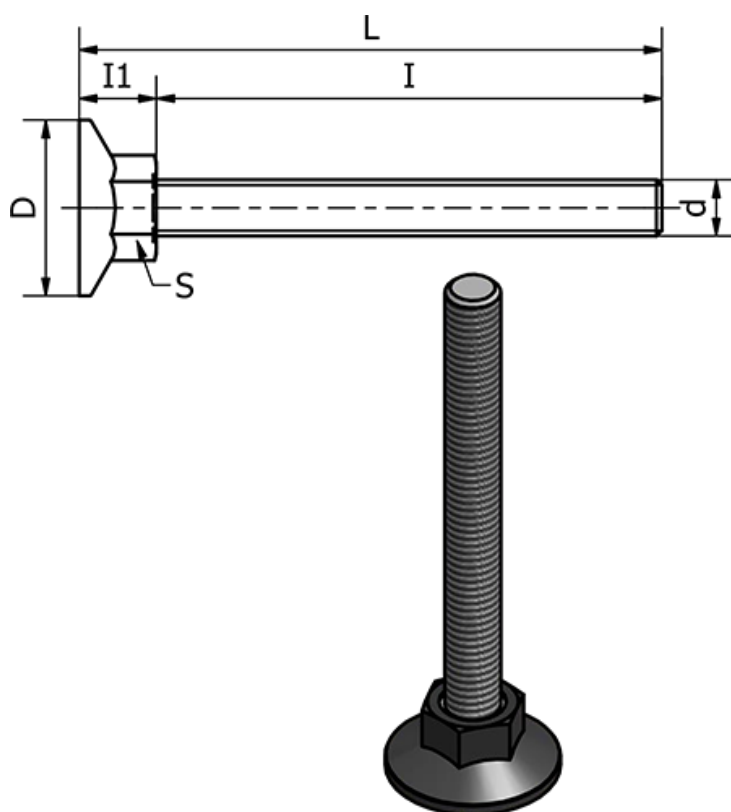

d	= M8
D	= 30
I	= 23
I1	= 12
L	= 35
Max statisk belastning (N)	= 2500
S	= 17
Type	= AISI 304 Rustfast

Vægt (g) = -